

APS BATTERIES Manual

[Specifications](#)

[Description](#)

[Package contents](#)

[Precautions](#)

[Recommendations for Battery Use](#)

[Battery charging](#)

[Legal Compliances and Disclaimers](#)

Specifications

Model	APS 5T
SKU	79188
Type	Li-ion
Nominal capacity at +22°C (72°F)	4900 mAh
Rated voltage	3.7 V
Charge/discharge cycles, minimum*	500
Charge/discharge ambient temperature	0°C...+35°C/-25°C...+50°C (+32°F...+95°F/-13°F...+122°F)
Dimensions	92 × 25 × 25 mm (3.62 × 1 × 1 inches)
Weight	0.08 kg (2.9 oz)

* Once reached the specified limit, the battery capacity may drop to 80%. This is normal and not a defect.

Description

APS 5T rechargeable lithium-ion power supplies are designed for use with thermal imaging riflescopes Pulsar Talion.

APS 5T batteries support USB Power Delivery fast charging technology when using a standard charging set (charger, USB Type-C cable, power adapter).

Package contents

- APS 5T battery
 - Operating Manual
 - Warranty card
-

Precautions

- Only use the charger supplied with the Battery Pack (may not be included). The use of any other charger may irreparably damage the Battery Pack or the charger and may cause fire.
- Do not charge the battery immediately after bringing it from cold to warm. Wait at least 30 minutes for the battery to warm up.
- It is not recommended to charge the batteries with a charger connected to the USB port of a computer or laptop. It can damage the computer.
- Do not leave the battery unattended while charging.
- Do not use the charger if it has been modified or damaged.
- Do not leave the battery in a charger connected to the mains after charging is complete.
- Do not expose the battery to high temperatures or naked flames.
- Do not use the battery as a power source for devices that do not support APS batteries.
- Do not disassemble or deform the battery or charger.
- Do not drop or strike the battery or charger.
- The battery and charger must not be immersed in water.
- Keep the battery out of the reach of children.

Recommendations for Battery Use

- The batteries should be partially charged (50 to 80 %) for long-term storage.
- The battery is to be charged at an ambient temperature of 0 °C to +35 °C or the lifespan of the battery will decrease significantly.
- When using the battery at sub-zero ambient temperatures, the battery capacity decreases. This is normal and not a defect.
- Do not use the battery at temperatures outside the range of -25 °C to +40 °C or it may reduce battery life.
- The battery is short circuit protected. However, any situation that may cause short-circuiting should be avoided.



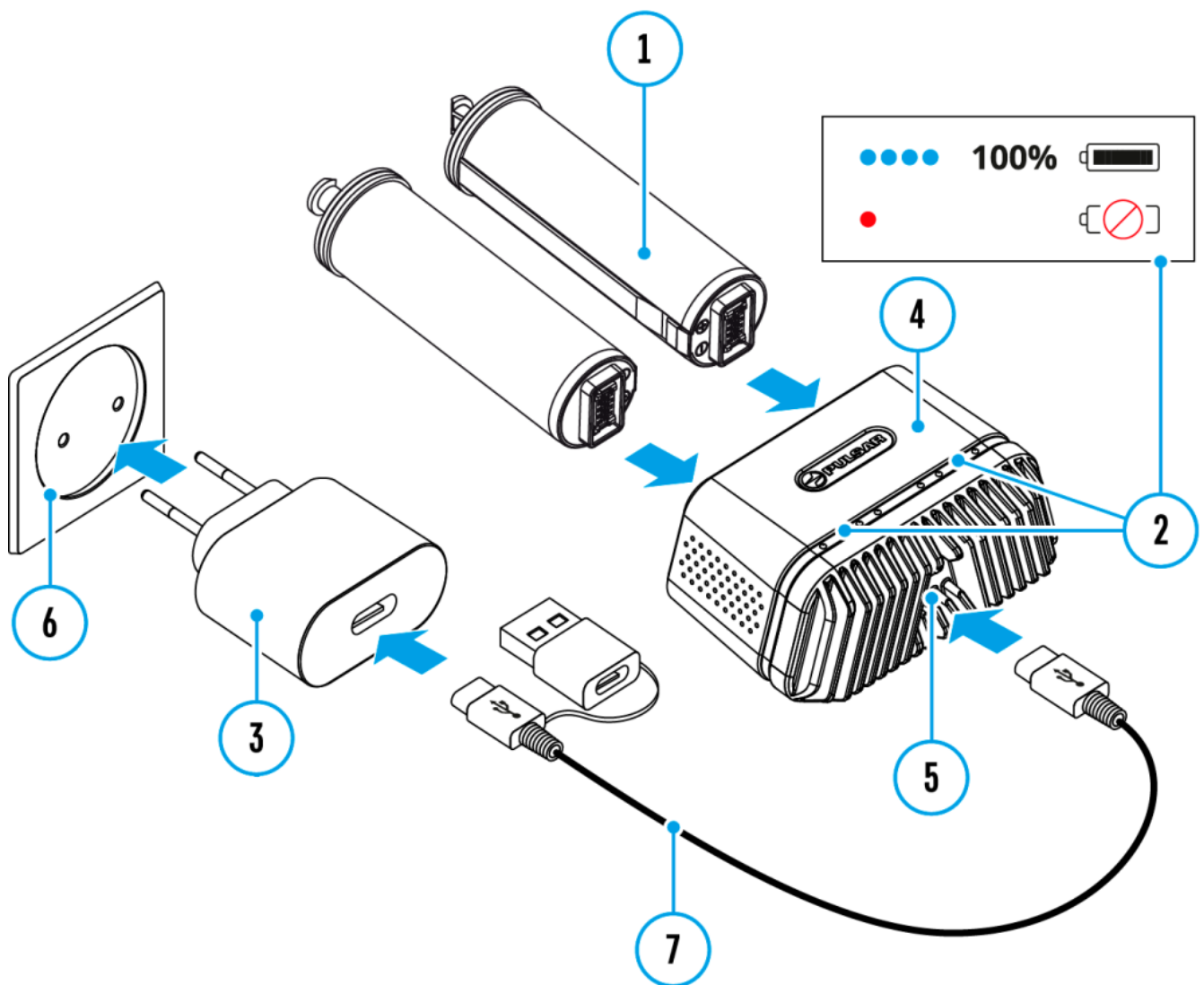



Battery charging



1. Insert the battery **(1)** along the guide to the stop into the APS 5* charger slot **(4)** (see. Fig.).
2. Connect the plug of the USB Type-C cable* **(7)** to the USB Type-C connector of the power adapter* **(3)**. Plug the power adapter **(3)** into a socket 100-240 V (110 V for US) **(6)**.
3. Connect the other end of the USB Type-C cable to the USB Type-C connector **(5)** of the charger **(4)** by removing the USB Type-A adapter.
4. LED indication **(2)** will display battery charge level (see Table).
5. Two batteries can be charged at the same time: the second slot is designed for it.







LED indication (2) in the battery charging mode

Battery Level

	Battery charge level is from 0% to 25%
	Battery charge level is from 26% to 50%
	Battery charge level is from 51% to 80%
	Battery charge level is from 81% to 99%
	Battery is fully charged. Charging will automatically stop. The battery can be disconnected from the charger.
	Defective battery. Do not use the battery!

LED indication (2) in the standby mode**

Battery Level

	Battery charge level is from 0% to 25%
	Battery charge level is from 26% to 50%
	Battery charge level is from 51% to 80%
	Battery charge level is from 81% to 99%
	Battery is fully charged. It can be disconnected from the charger.
	Defective battery. Do not use the battery!

Attention! When using a power adapter that does not support USB Power Delivery fast charging technology, the flicker frequency of LED indicators is reduced by 3 times.

Attention! The charger heats up during fast charging. Excess heat is removed through the radiator and does not affect the device operation.

* Purchased separately or supplied as package contents of a device.

** Standby mode – an operating mode in which batteries are inserted into the charger, but the power adapter is not connected. In this mode, the indication is on for 10 seconds.

Legal Compliances and Disclaimers

Updates of the Product. The manufacturer reserves the right at any time, without mandatory prior notice to the Customer, to make changes to the package contents (subject to the applicable laws, if any), design and characteristics that do not impair the quality of the Product.

Repair. warranty for the Battery Pack is one year.

Limitation of Liability. Subject to mandatory applicable laws and regulations: manufacturer will not be liable for any claims, actions, suits, proceedings, costs, expenses, damages or liabilities (if any), arising out of the use of this product. Operation and use of the product are the sole responsibility of the Customer. Manufacturer's sole undertaking is limited to providing the product(s) and related services in accordance with the terms and conditions of concluded transactions, including provisions established in warranty. The provision of products sold and services performed by Manufacturer to the Customer shall not be interpreted, construed, or regarded, either expressly or implied, as being for the benefit of or creating any obligation toward any third party (other than Distributor, Dealer, Buyer). Manufacturer's liability hereunder for damages, regardless of the form or action, shall not exceed the fees or other charges paid to Manufacturer for the product(s) and/or service(s).

MANUFACTURER WILL NOT BE LIABLE FOR LOST REVENUES OR INDIRECT, SPECIAL, INCIDENTAL, CONSEQUENTIAL, EXEMPLARY, OR PUNITIVE DAMAGES, EVEN IF THE MANUFACTURER KNEW OR SHOULD HAVE KNOWN THAT SUCH DAMAGES WERE POSSIBLE AND EVEN IF DIRECT DAMAGES DO NOT SATISFY A REMEDY.

For technical support please contact support@pulsar-vision.com.

Answers to frequently asked questions about the devices can also be found in the **FAQ** section.

C E UK
CA

